

1T7054 | OZ Ceiling/Suspension installation profile

Ceiling/suspension installation profile for 25x25mm light modules

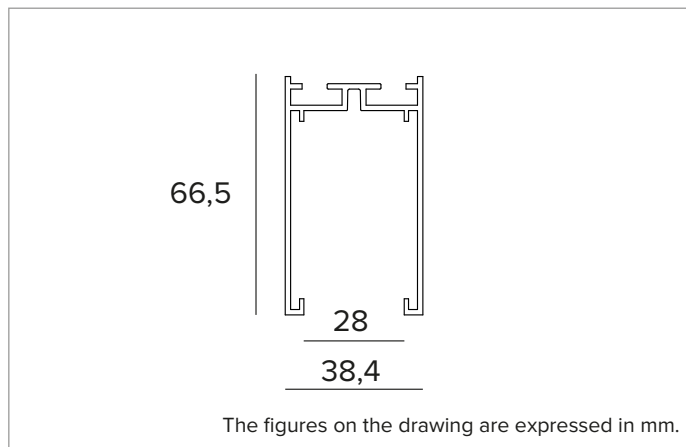
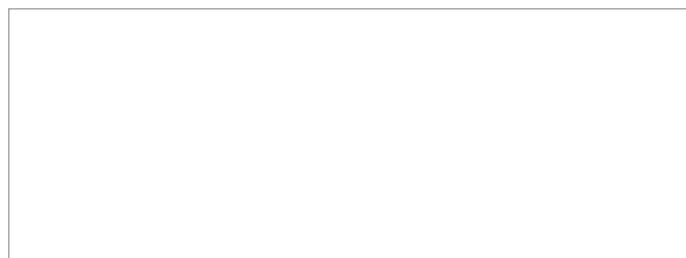
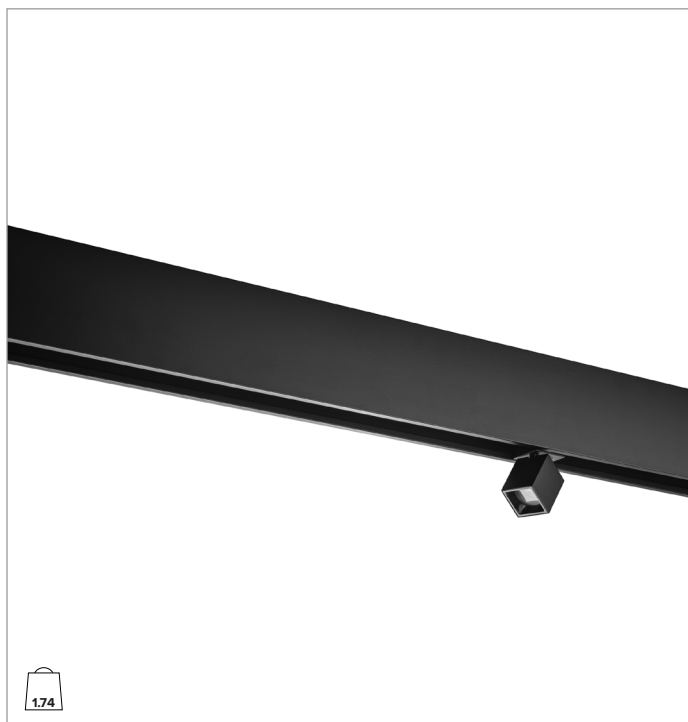

MECHANICAL CHARACTERISTICS

Extruded painted aluminium profile. Head module.

Colour and finish: Deep black

Dimensions: L=2015mm

Weight: 1.74Kg

Version: FOR 25x25mm LIGHT MODULES - HEAD MODULE

INSTALLATION

For stand-alone installation only used head modules. For system installation it is necessary to start the configuration with a head module. For closed configurations it is necessary to order a minimum of two head modules or multiples of two to install back to back.

NOTES

To be completed with Power Track.

WARRANTY

5 years.

WARNING

Luminaire designed for disposal/recycling at end-of-life.

Due to the technological evolution of the electronic components, the data provided may be updated, and as such, confirmation must be requested during the order process.

Luminous flux and power supply have +/-10% tolerances with respect to the indicated value. tq +25°C (CIE 121).

We reserve the right to make technical changes.

Targetti Sankey S.r.l.
Via Pratese, 164
50145 Firenze - Italy
Tel: +39 055 37911
targetti.com
targetti@targetti.com

CCIAA Firenze
Share Capital:
€ 500.000,00
VAT N. (IT):
01537660480
R.E.A: FI-275656

TARGETTI

1T7054 | OZ Ceiling/Suspension installation profile

Ceiling/suspension installation profile for 25x25mm light modules

Related codes

End Caps



Colour Code

● **1T7063**

Kit containing 2 profile end caps.
For small ceiling/suspension mounted profiles.

Mounting System



Code

1T7065

Ceiling installation kit.
2 pieces to be ordered for 1m long modules, 2 pieces for 2m long modules and 3 pieces for 3m long modules.

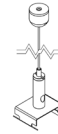

Code

1T7066

Suspension installation kit.
L=2000mm.
2 pieces to be ordered for 1m long modules, 2 pieces for 2m long modules and 3 pieces for 3m long modules.

Accessories

Mechanical connector

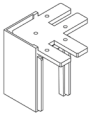

Colour Code

● **1T7059**

Mechanical L connector.
For small ceiling/suspension mounted profiles.



Colour Code

● **1T7060**

Mechanical T connector.
For small ceiling/suspension mounted profiles.



Colour Code

● **1T7061**

Mechanical X connector.
For small ceiling/suspension mounted profiles.



Colour Code

● **1T7097**

Linear mechanical joint, made of 4 mechanical joints and 4 screws.
For ceiling/suspension installation profile.

Due to the technological evolution of the electronic components, the data provided may be updated, and as such, confirmation must be requested during the order process.
Luminous flux and power supply have +/-10% tolerances with respect to the indicated value. tq +25°C (CIE 121).

We reserve the right to make technical changes.

Targetti Sankey S.r.l.
Via Pratese, 164
50145 Firenze - Italy
Tel: +39 055 37911
targetti.com
targetti@targetti.com

CCIAA Firenze
Share Capital:
€ 500.000,00
VAT N. (IT):
01537660480
R.E.A.: FI-275656

TARGETTI

1T7054 | OZ Ceiling/Suspension installation profile

Ceiling/suspension installation profile for 25x25mm light modules

Cover Panel



L mm	Colour	Code
1000	●	1T9597
2000	●	1T9598

Cover for small profiles for ceiling/suspension installation.

Due to the technological evolution of the electronic components, the data provided may be updated, and as such, confirmation must be requested during the order process.

Luminous flux and power supply have +/-10% tolerances with respect to the indicated value. tq +25°C (CIE 121).

We reserve the right to make technical changes.

Targetti Sankey S.r.l.
Via Pratese, 164
50145 Firenze - Italy
Tel: +39 055 37911
targetti.com
targetti@targetti.com

CCIAA Firenze
Share Capital:
€ 500.000,00
VAT N. (IT):
01537660480
R.E.A: FI-275656

TARGETTI